

NO SCALE

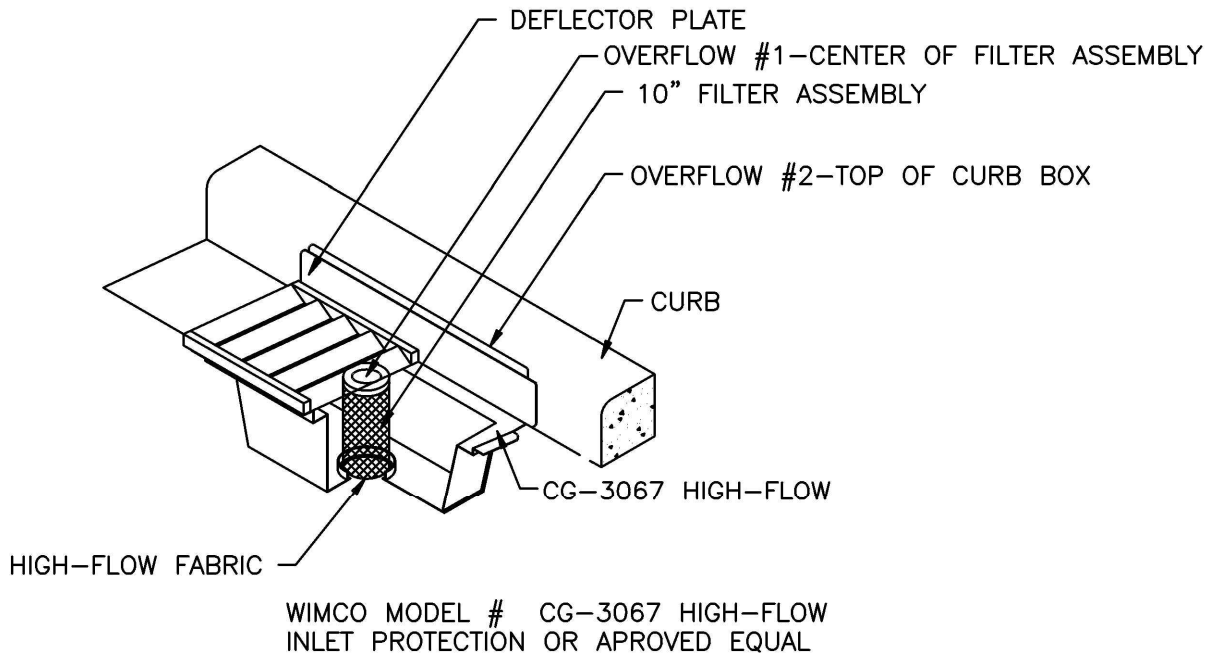

CURB AND GUTTER INSTALLATION

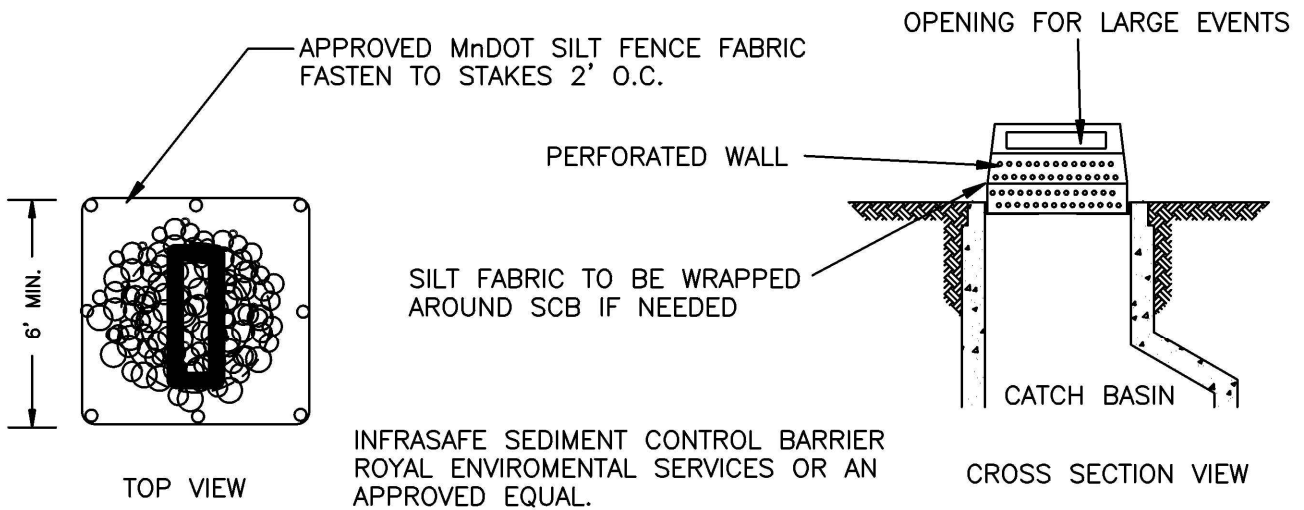

PLACEMENT OF SEDIMENT CONTROL DEVICES WITH
 SILT FENCE FOR REAR YARD INLET PROTECTION.



STORM SEWER
 EROSION CONTROL DETAILS

PLATE NO. LV-STM-12

DATE 02/2024